

Airport Obstruction Standards



Dr. Antonio Trani

Department of Civil and Environmental Engineering

Virginia Tech



Outline of this Presentation

- Obstructions to navigation around airports
- Discussion of Federal Aviation Regulations (FAR) Part 77 obstacle standards
- Examples using FAR Part 77 rules
- ICAO standards



FAR Part 77 Basics

- Objects affecting navigable airspace
 - Federal Aviation Regulation Part 77
 - “Federal Regulation 49 CFR Part 77 establishes standards and notification requirements for objects affecting navigable airspace.”
 - Available on the web at: <https://www.govinfo.gov/content/pkg/CFR-2012-title14-vol2/xml/CFR-2012-title14-vol2-part77.xml>



What is the Issue?

- Evaluates the effect of the construction or alteration on operating procedures

Determines the potential hazardous effect of the proposed construction or alterations on air navigation

Identifies mitigating measures to enhance safe air navigation

Charts new man-made or natural objects.

FAR Part 77 allows the “FAA to identify potential aeronautical hazards in advance thus preventing or minimizing the adverse impacts to the safe and efficient use of navigable airspace”



FAA Responses

Once the FAA has completed an aeronautical study, a determination is made regarding the impact to air navigation. One of three responses is typically issued:

No Objection - "The subject construction did not exceed obstruction standards and marking/lighting is not required."

Conditional Determination - "The proposed construction/alteration would be acceptable contingent upon implementing mitigating measures (marking and lighting, etc.)"

Objectionable - "The proposed construction/alteration is determined to be a hazard and is thus objectionable. The reasons for this determination are outlined to the proponent."

Source: FAA Part 77



Obstructions to Navigation

In the **United States**, an object constitutes an obstruction to navigation if:

- If 200 ft. above ground level or 200 ft. above the airport elevation (whichever is greater) up to 3 miles (for runway lengths > 3200 ft.) from the airport.
- Increase 100 ft. every mile up to 500 ft. at 6 miles from the ARP (airport reference point)
- Is 500 ft. or more above ground level at the object site
- If penetrates an imaginary surface (a function of the precision of the runway)
- If penetrates the terminal obstacle clearance area (includes initial approach segment)
- If penetrates the enroute obstacle clearance area (includes turn and termination areas of federal airways)



Obstructions to Navigation (Part 77.17)

In the **United States**, an object constitutes an obstruction to navigation if it is of greater height than any of the following heights or surfaces:

- (b) Except for traverse ways on or near an airport with an operative ground traffic control service furnished by an airport traffic control tower or by the airport management and coordinated with the air traffic control service, the standards of paragraph (a) of this section apply to traverse ways used or to be used for the passage of mobile objects only after the heights of these traverse ways are increased by:
 - 17 feet for an Interstate Highway that is part of the National System of Military and Interstate Highways where overcrossings are designed for a minimum of 17 feet vertical distance.
 - 15 feet for any other public roadway.
 - 10 feet or the height of the highest mobile object that would normally traverse the road, whichever is greater, for a private road.
 - 23 feet for a railroad.
 - For a waterway or any other traverse way not previously mentioned, an amount equal to the height of the highest mobile object that would normally traverse it.



FAR Part 77 Imaginary Surfaces

- **Primary** = aligned (longitudinally) with each runway and extends 200 ft. from each runway end
- **Approach** = longitudinally centered with the runway and extends beyond the primary surface
- **Horizontal** = horizontal plane 150 ft. above the established airport elevation. Constructed by swinging arcs around the end of the primary surface
- **Conical** = 20:1 slope surface extending beyond the horizontal surface
- **Transitional** = constructed to join approach and horizontal or approach and transitional surfaces



Graphical Depiction (FAR 77 Surfaces)

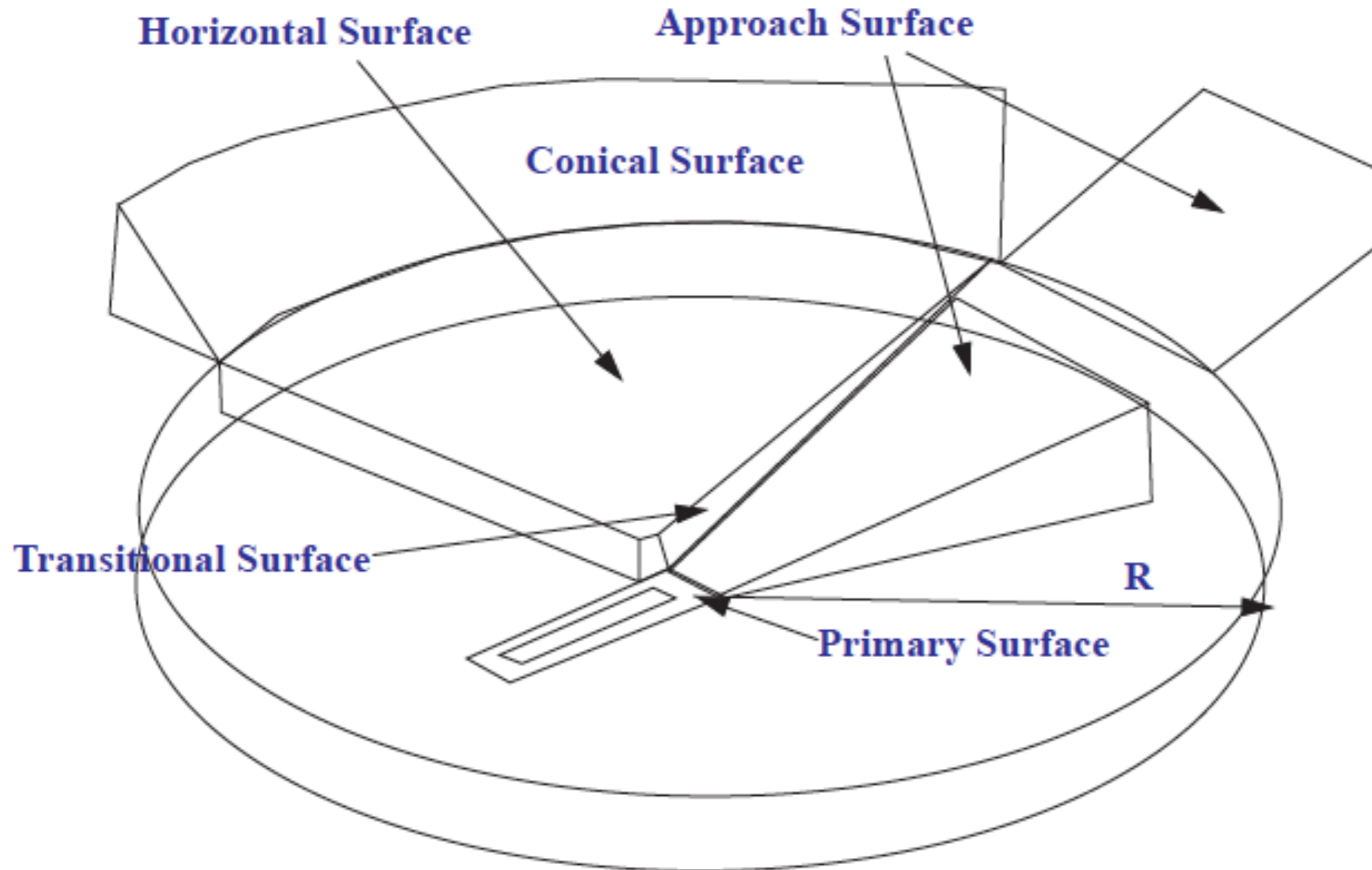



FAR Part 77 Imaginary Surfaces

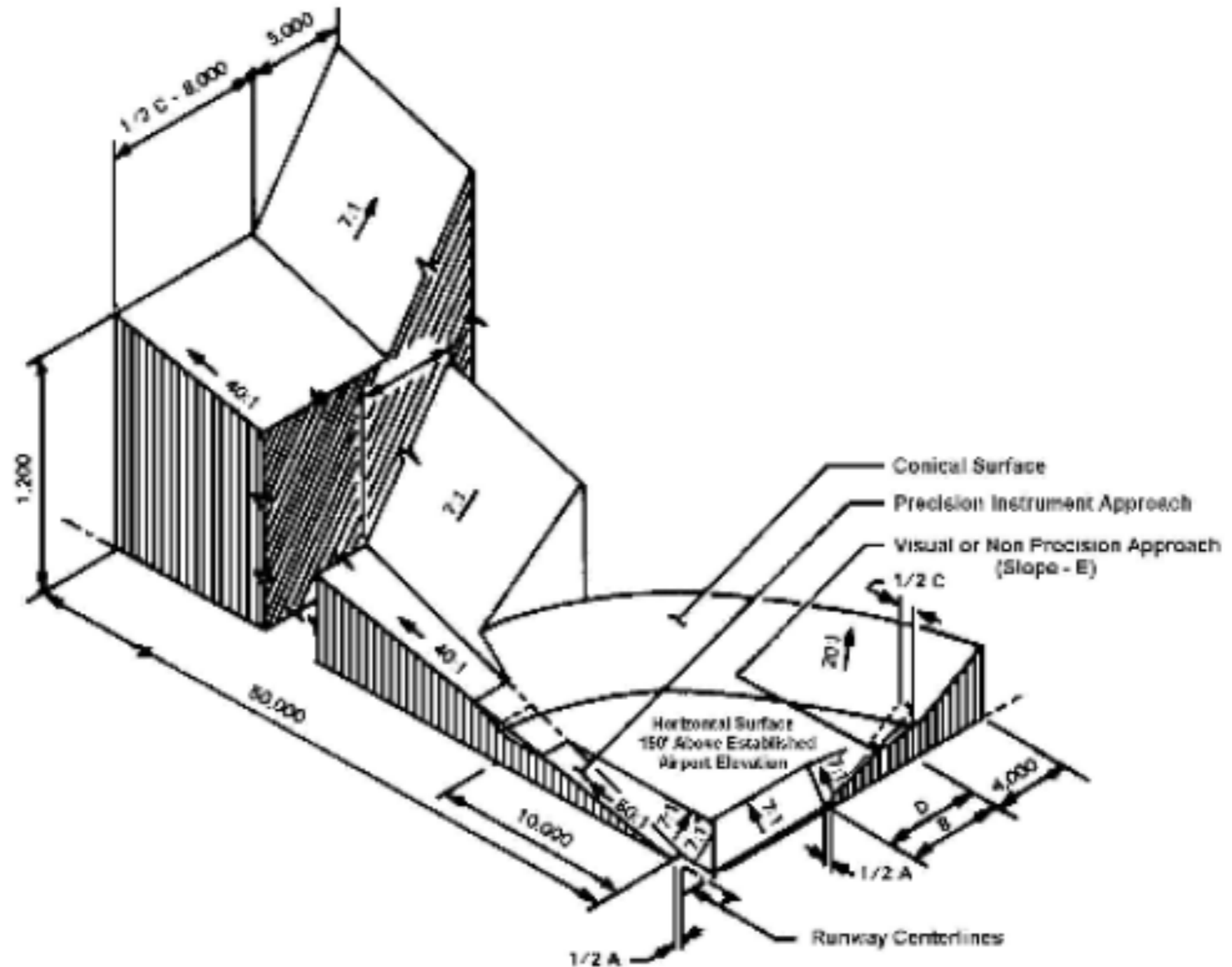

Source: <http://www.ngs.noaa.gov/AERO/oisspec.html>



Two-Dimensional Graphical Depiction

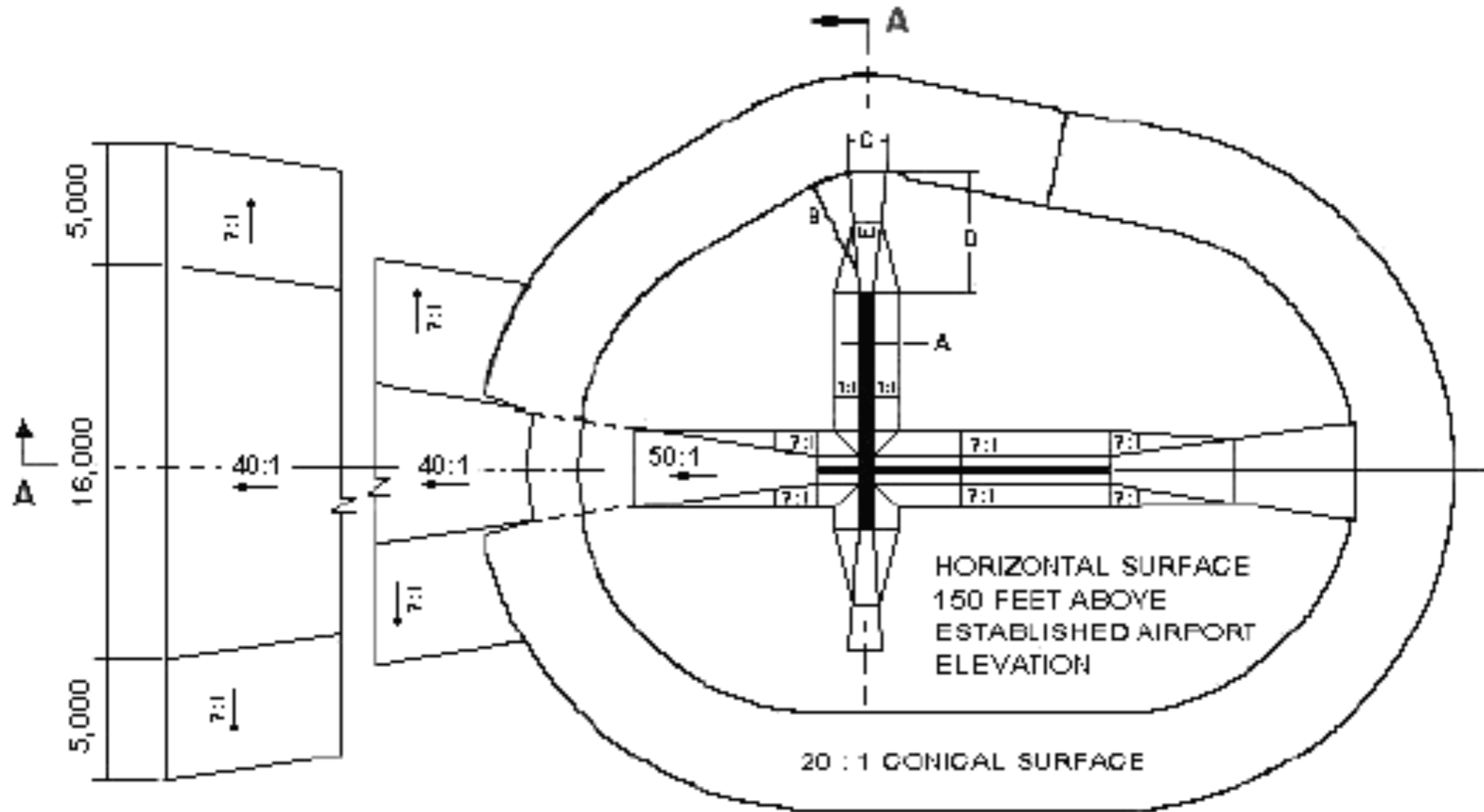

Source: <http://www.ngs.noaa.gov/AERO/yplanfar77.gif>

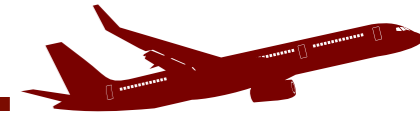

United States FAR 77 Dimensions

OBSTRUCTION IDENTIFICATION SURFACES FEDERAL AVIATION REGULATIONS PART 77

DIM	ITEM	DIMENSIONAL STANDARDS (FEET)					
		VISUAL RUNWAY		NON - PRECISION INSTRUMENT RUNWAY		PRECISION INSTRUMENT RUNWAY	
		A	B	A	B		
					C	D	
A	WIDTH OF PRIMARY SURFACE AND APPROACH SURFACE WIDTH AT INNER END	250	500	500	500	1,000	1,000
B	RADIUS OF HORIZONTAL SURFACE	5,000	5,000	5,000	10,000	10,000	10,000
		VISUAL APPROACH		NON - PRECISION INSTRUMENT APPROACH		PRECISION INSTRUMENT APPROACH	
		A	B	A	B		
					C	D	
C	APPROACH SURFACE WIDTH AT END	1,250	1,500	2,000	3,500	4,000	16,000
D	APPROACH SURFACE LENGTH	5,000	5,000	5,000	10,000	10,000	*
E	APPROACH SLOPE	20:1	20:1	20:1	34:1	34:1	*

- A - UTILITY RUNWAYS
- B - RUNWAYS LARGER THAN UTILITY
- C - VISIBILITY MINIMUMS GREATER THAN 3/4 MILE
- D - VISIBILITY MINIMUMS AS LOW AS 3/4 MILE
- * - PRECISION INSTRUMENT APPROACH SLOPE IS 50:1 FOR INNER 10,000 FEET AND 40:1 FOR AN ADDITIONAL 40,000 FEET

Source: <http://www.ngs.noaa.gov/AERO/oisspec.html>



Runway Displaced Thresholds

- Sometimes is not possible to comply with all FAR 77 criteria (specially the five imaginary surfaces)
 - Runway displaced thresholds have to be defined to meet the criteria
 - NOTE: highways and railroads are considered obstructions that need adjustments as follows:
 - **10 ft. or the height of the tallest vehicle using the road**
 - **15 ft. for public roads**
 - **17 ft. for interstate highways**
 - **23 ft. for railroads (or the highest railroad vehicle)**



Example Problem

The **end of a precision runway** at San Bernardo Airport is located 3,000 ft. from a newly constructed elevated Light Rail Transit (LRT) line as shown in the Figure (next page)

- a) Is the pantograph pole an obstruction to navigation? Explain.
- b) Suggest alternatives to use Runway 34 if this one cannot be relocated. Explain the runway length limitations for departures and arrivals to comply with FAR Part 77.

Elevated Freeway Section at San Bernardo Runway 34.



Sample Problem

- Determine if the LRT system constitutes an obstacle to navigation
- Assume the airport served commercial operations and the runway is a precision runway

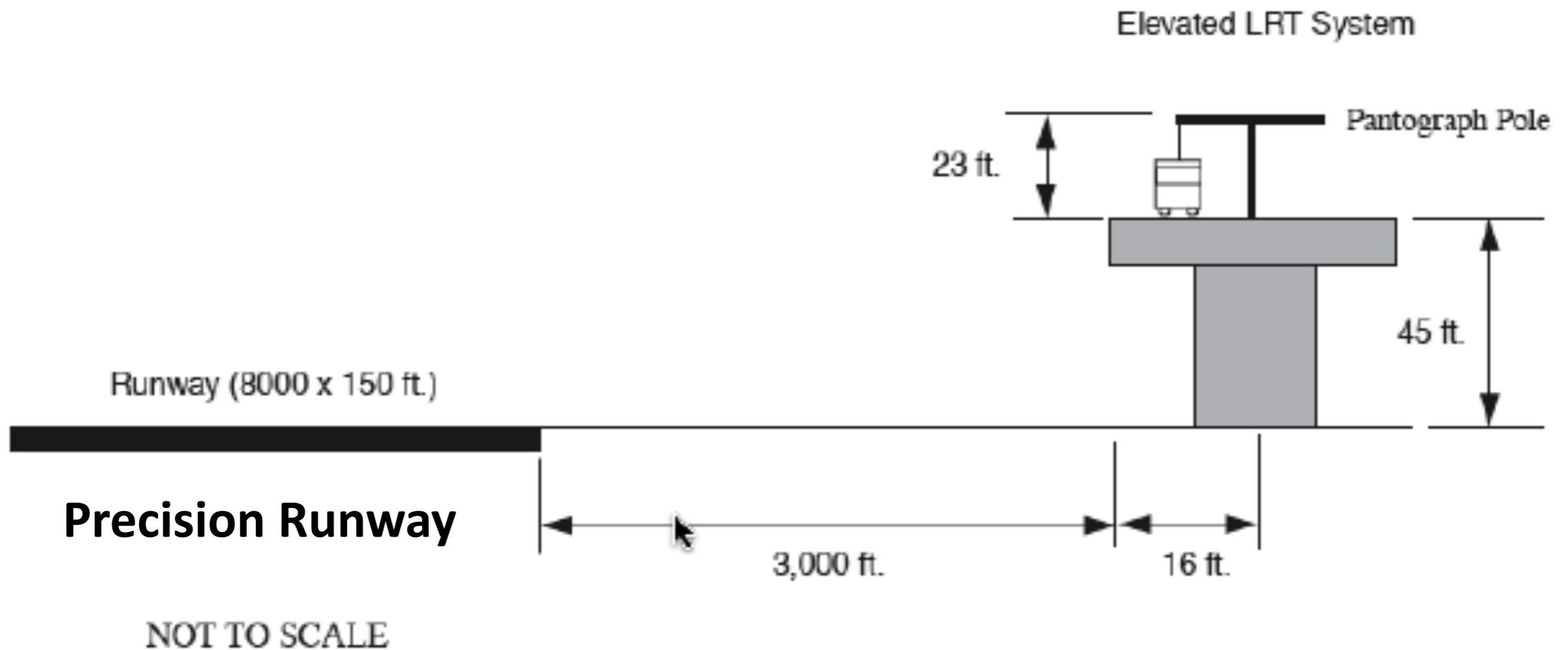



Preliminary Analysis

- A precision runway requires the highest degree of protection possible

Note that the approach surface has a changing slope from 50:1 to 40:1

Surface	Visual		Non-Precision Instrument Runway			Precision Instrument Runway
	A	B	A	C	D	All
Width of Primary Surf. and inner App. Surface	250	500	500	500	1,000	1,000
Radius of Horizontal Surface	5,000	5,000	5,000	10,000	10,000	10,000
Approach Surface at Outer End	1,250	1,500	2,000	3,500	4,000	16,000
Approach Surface Length	5,000	5,000	5,000	10,000	10,000	50,000
Approach Slope	20:1	20:1	20:1	34:1	34:1	50:1 ^a

a. First 10,000 feet the slope is 50:1, then 40:1 for the remaining 40,000 feet. up to 50,000 ft.



Calculations

1. Point of interest is located 2,800 feet from the start of the approach surface
2. At the point of interest, the approach surface height is $(2800 / 50) = 56$ feet
3. LRT Pantograph is 68 feet tall
4. LRT is an obstacle to navigation

Slope of the Approach Surface

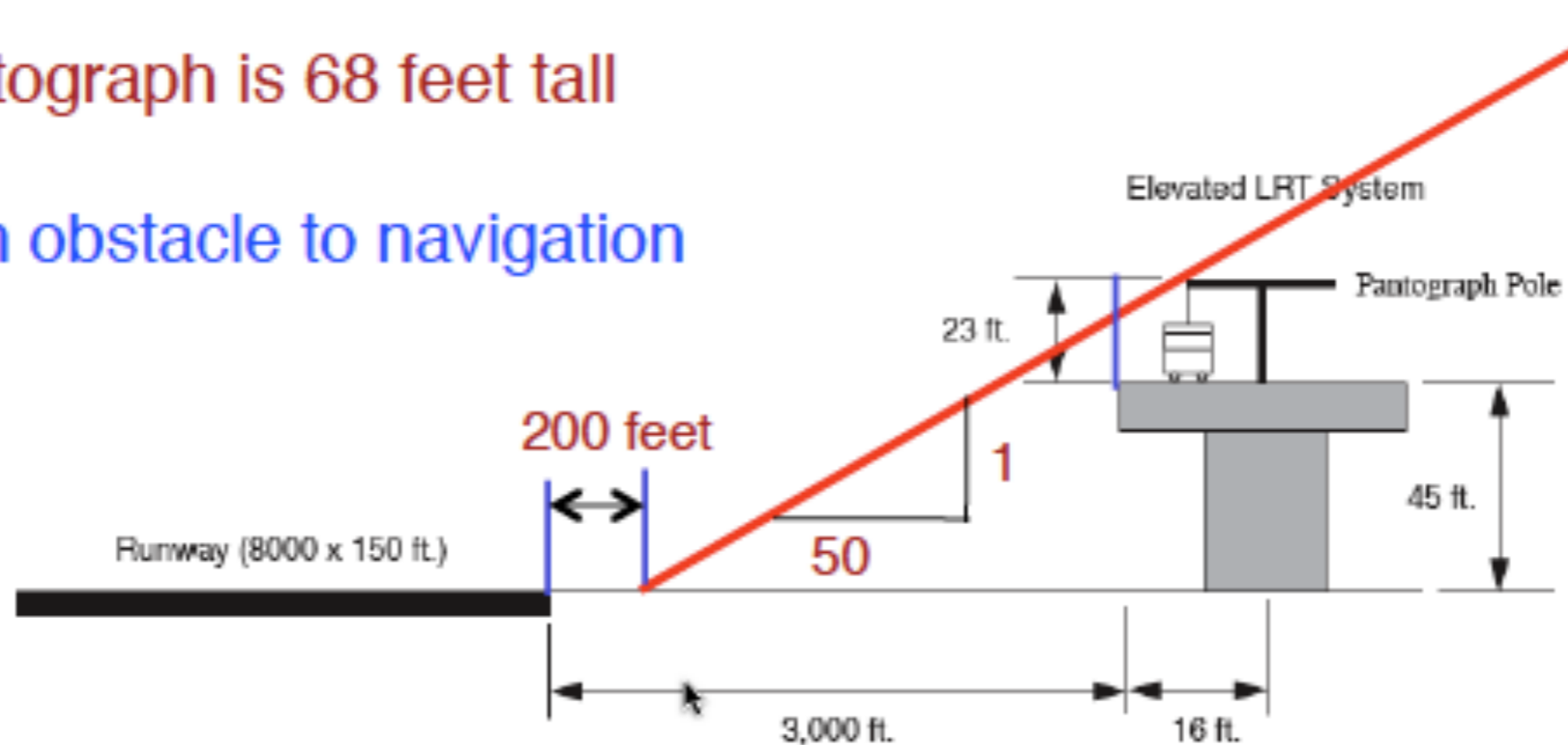

NOT TO SCALE



Remedial Action: Displace the Threshold

1. The LRT height tops the approach surface by 12 feet
2. Find distance $x = 3,600$ feet
3. Need to displace the runway threshold by 600 feet

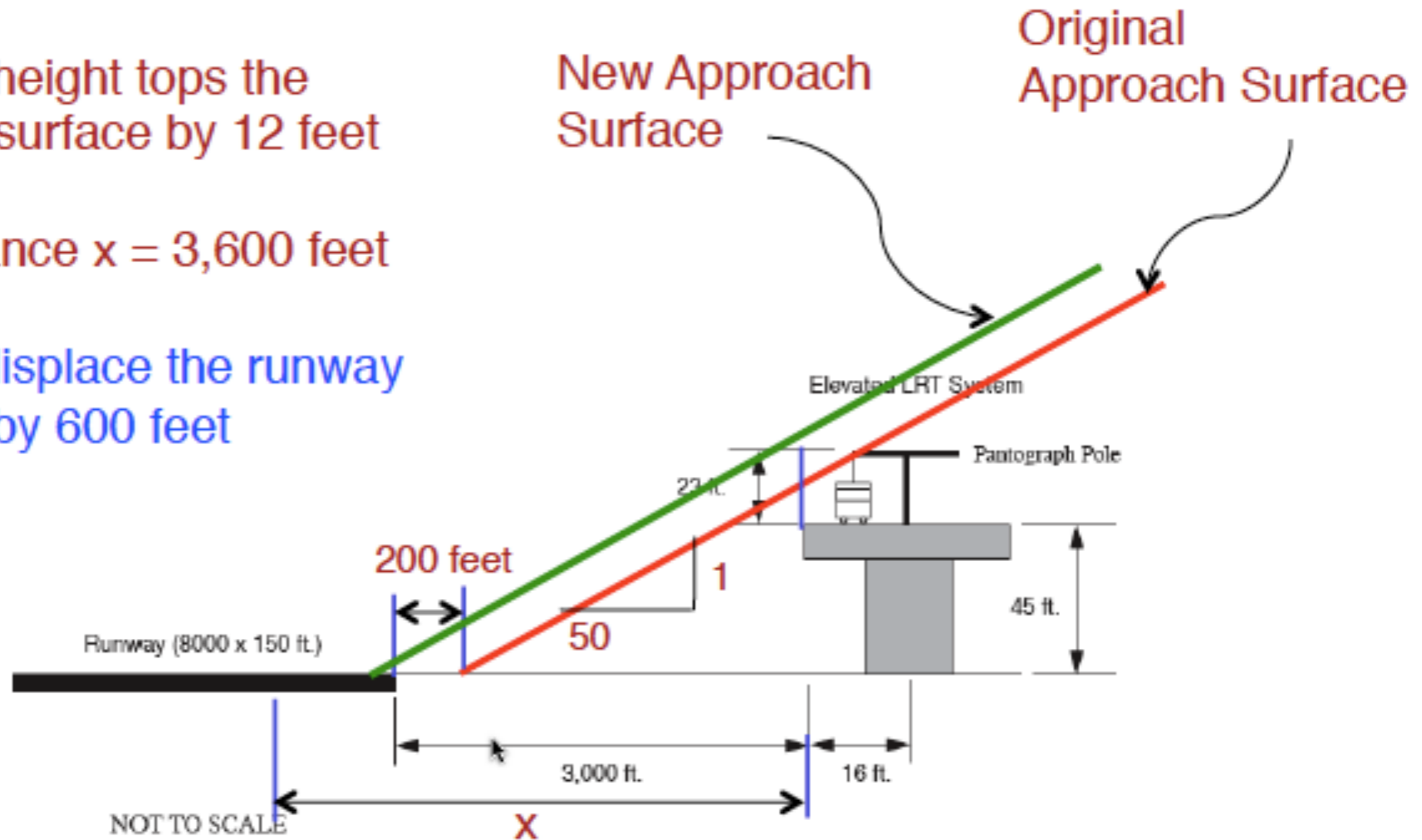

x = displaced threshold distance



Operational Implications

- Landing runway length available (LDA) is reduced by 600 feet
- This could have serious operational limitations for an airline flying into the airport
- Takeoff distance available (TODA) remains the same for West departures
- The protection for East departures would have to be considered separately

NOTE: ICAO defines approach and departure surfaces independently



Another Example (Problem 2)

You are conducting an FAR part 77 study for a proposed 8,500 ft. precision runway with an Instrument Landing System (ILS). The objects of concern are located at distances as shown in Figure 1 (distances are given as x-y coordinates referenced from the end of the runway as shown)

Determine the critical imaginary surface for each object. Explain whether the object is an obstruction to navigation

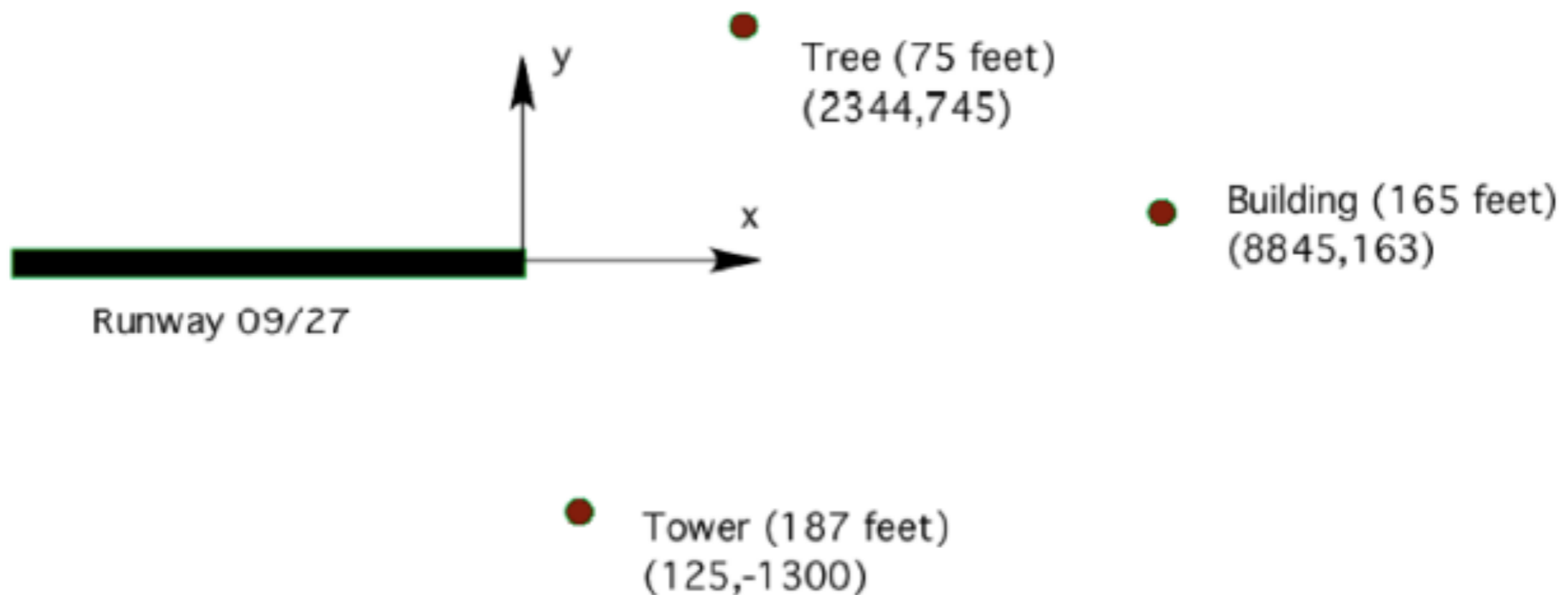



Draw the Imaginary Surfaces and Points of Interest

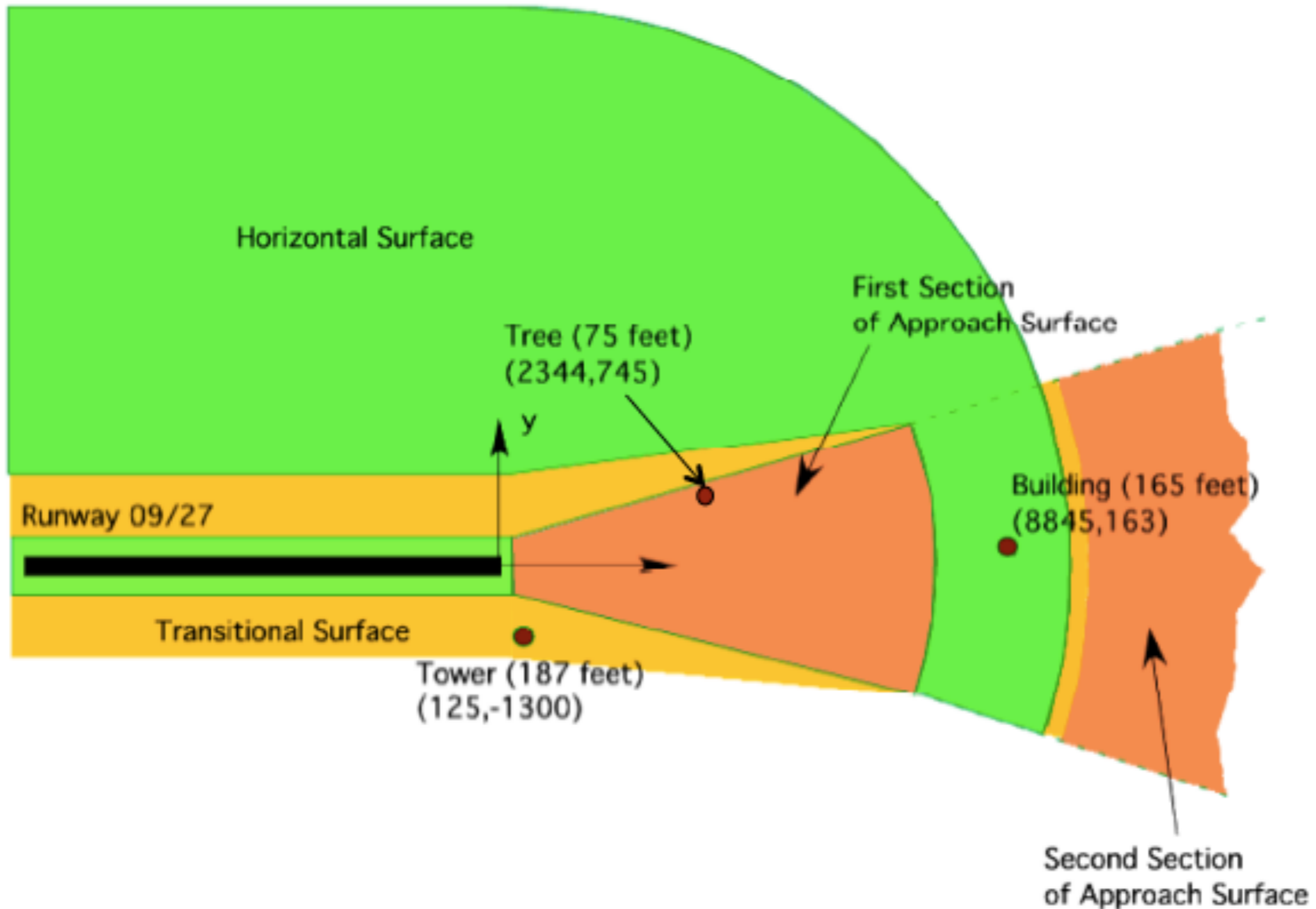



Analysis for the Building

The building is 8,845 feet from the runway threshold (8,645 feet from the starting point of the approach surface)

This point lies in the region where the horizontal surface is actually lower than the approach surface (see Figure)

The building constitutes an obstruction to navigation because it pierces the **horizontal surface**

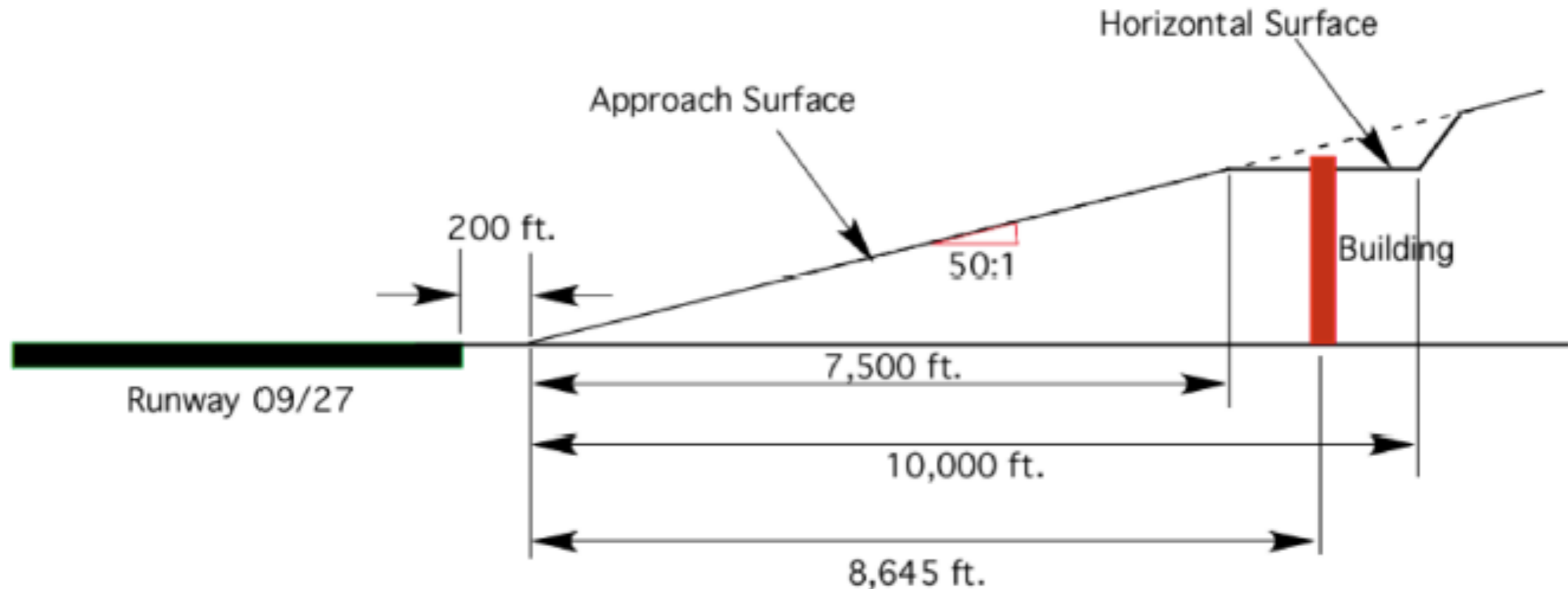



Analysis for the Tree

- The elevation of the approach surface 2,144 feet from the starting point of the approach surface is 42.88 feet
- The tree is 75 feet tall and is located 745 feet from the extension of the runway centerline
- At that location, the semi-width of the approach surface is 821.6 feet. The **tree lies inside the approach surface.**
- The tree violates the **approach surface**

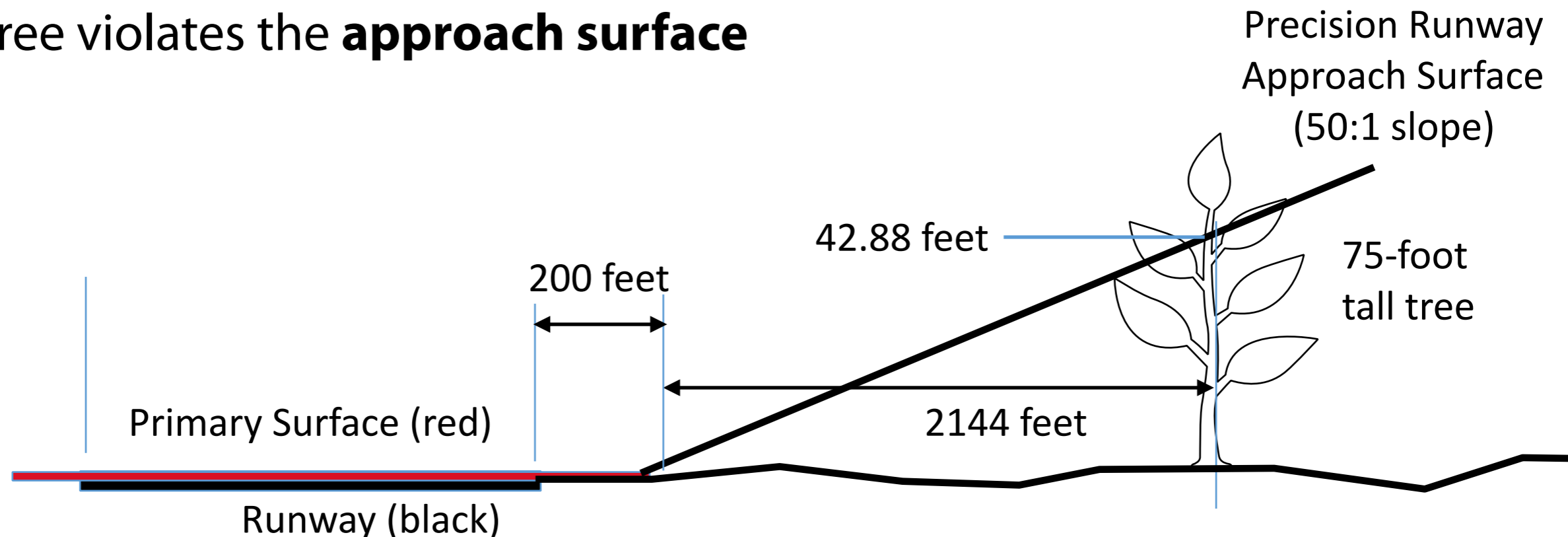



Analysis for the Tower

- The tower is an obstruction because it pierces the transitional surface
- The horizontal surface starts 1,050 feet from the edge of the primary surface (on the side) and starts 1550 feet from the runway centerline.
- The transitional surface slope is 7:1.
- Height of transitional surface is 114.3 feet at 1,300 feet.
- **The 187 foot tower violates the transitional surface**

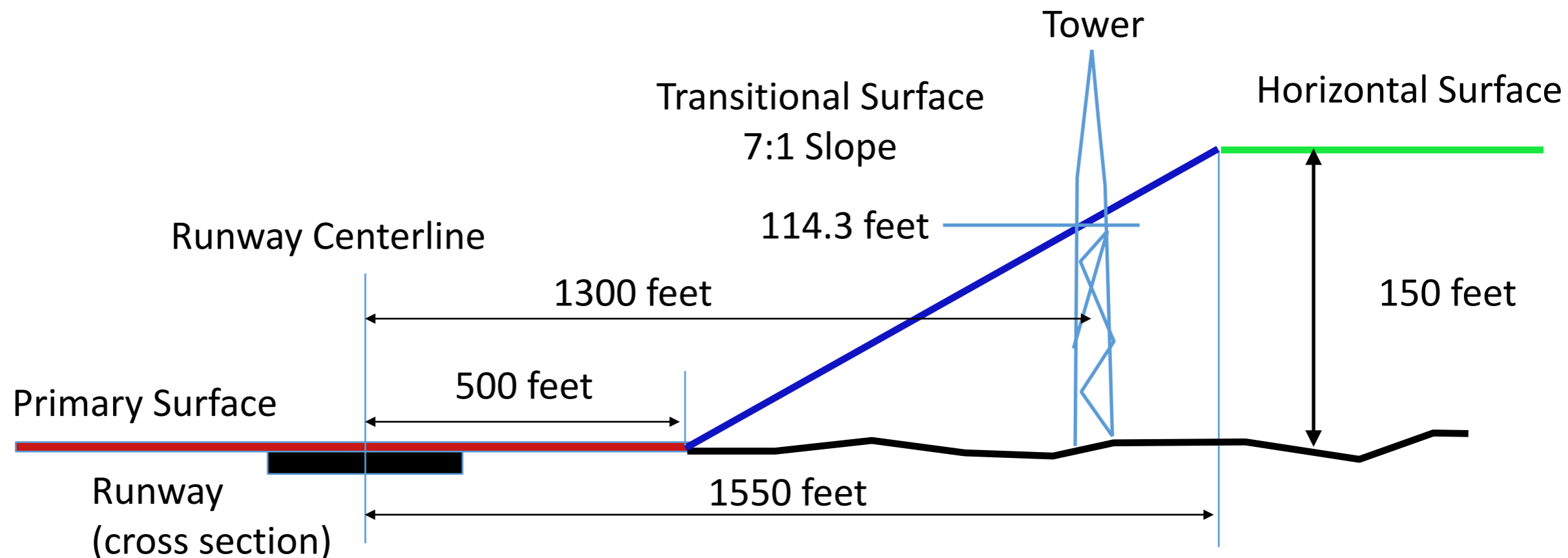



FAA Airport Obstacle Database

- We can find the critical obstacle to each runway en using the FAA obstacle database
- Critical obstacles are reported in runway databases like airnav.com

Runway Information

Runway 13/31

Dimensions: 5501 x 100 ft. / 1677 x 30 m
 Surface: asphalt/grooved, in fair condition

Runway edge lights: medium intensity

Runway edge markings: NSTD TAXIWAY IN-LINE WITH RWY. WHITE ARROW SHOULD BE YELLOW. THRESHOLD IS END OF RWY.

RUNWAY 13

Latitude: 37-12.770175N

Longitude: 080-25.229450W

Elevation: 2119.2 ft.

Traffic pattern: left

Runway heading: 125 magnetic, 117 true

Markings: nonprecision, in good condition

Visual slope indicator: 4-light PAPI on left (3.44 degrees glide path)

Approach lights: ODALS: omnidirectional approach lighting system

Runway end identifier lights: yes

Touchdown point: yes, no lights

Instrument approach: LOC/DME

Obstructions: 5 ft. sign, 313 ft. from runway, 57 ft. right of centerline, 22:1 slope to clear

Virginia Tech Montgomery County Executive Airport (BCB)

RUNWAY 31

37-12.356178N

080-24.221388W

2119.5 ft.

left

305 magnetic, 297 true

nonprecision, in good condition

2-light PAPI on left (3.00 degrees glide path)

yes

yes, no lights

8 ft. brush, 391 ft. from runway, 163 ft. right of centerline, 23:1 slope to clear



ICAO Standards

- Information contained in Chapter 4 of the Aerodrome Design Manual (Volume 1)
- While the general guidelines of ICAO surfaces follow similar logic than FAR criteria, the dimensions of some surface are different

CHAPTER 4. OBSTACLE RESTRICTION AND REMOVAL

Note 1.— The objectives of the specifications in this chapter are to define the airspace around aerodromes to be maintained free from obstacles so as to permit the intended aeroplane operations at the aerodromes to be conducted safely and to prevent the aerodromes from becoming unusable by the growth of obstacles around the aerodromes. This is achieved by establishing a series of obstacle limitation surfaces that define the limits to which objects may project into the airspace.

Inner horizontal surface

4.1.4 *Description.— Inner horizontal surface.* A surface located in a horizontal plane above an aerodrome and its environs.

4.1.5 *Characteristics.—* The radius or outer limits of the inner horizontal surface shall be measured from a reference point or points established for such purpose.



ICAO Obstacle Limitation Surfaces

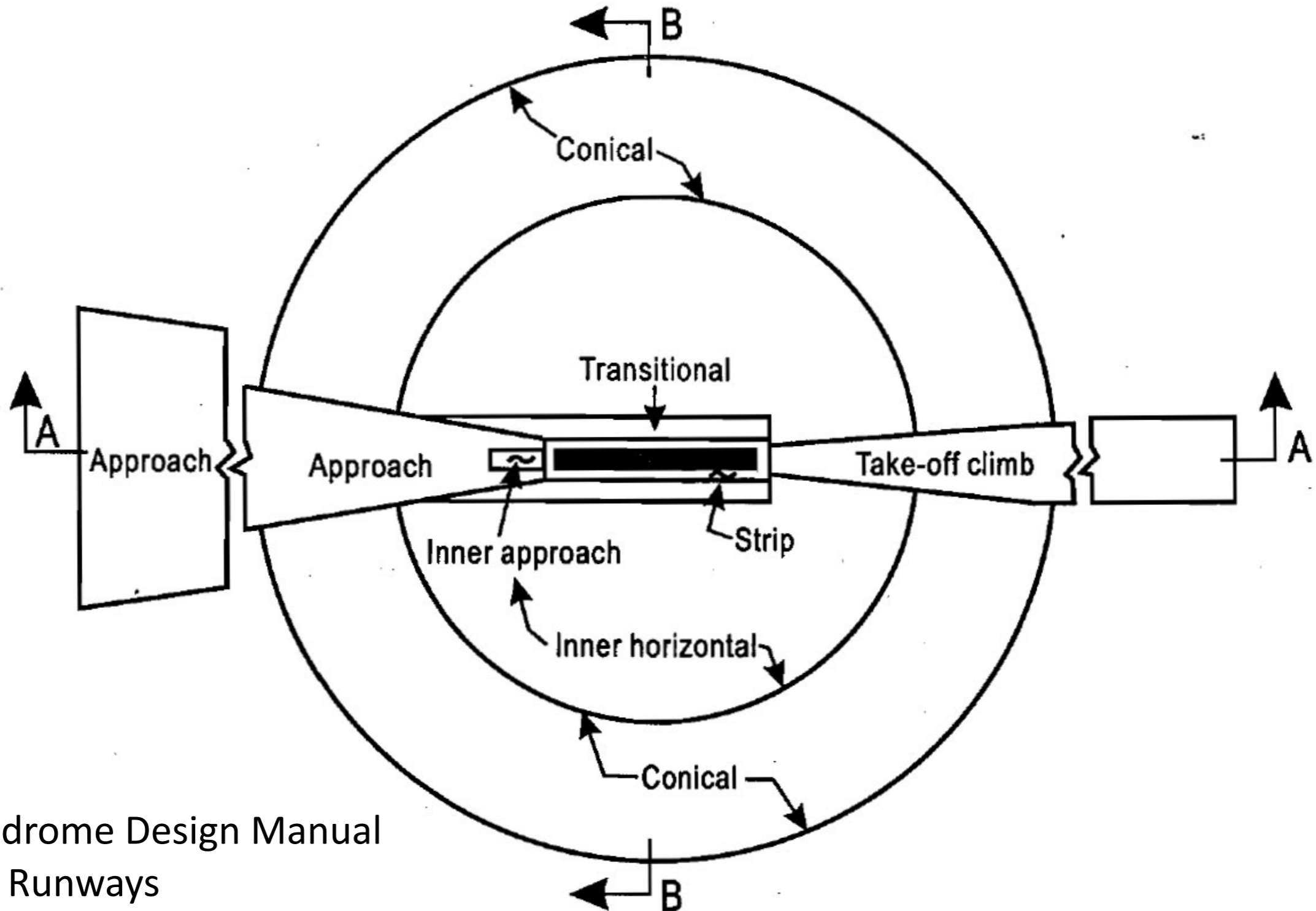

ICAO Aerodrome Design Manual
Volume 1: Runways



ICAO Obstacle Limitation Surfaces

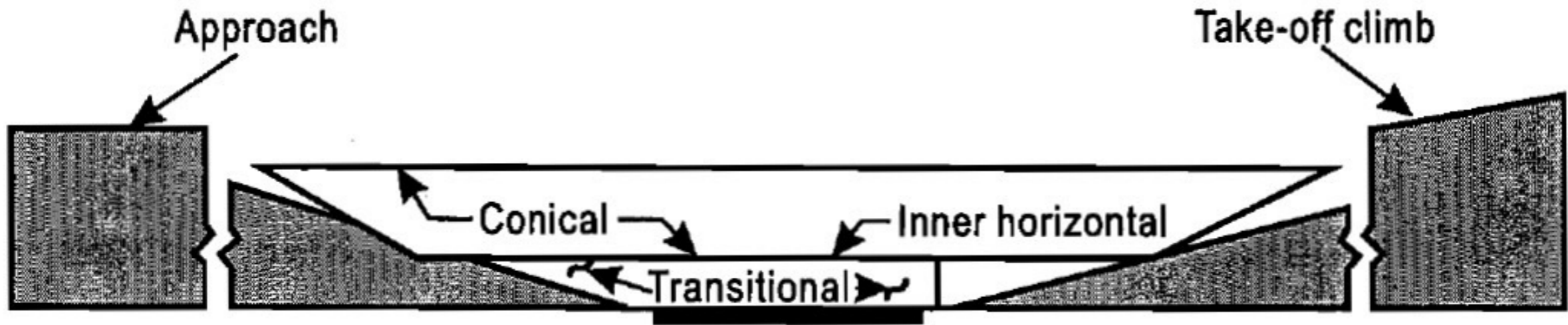

Section A-A

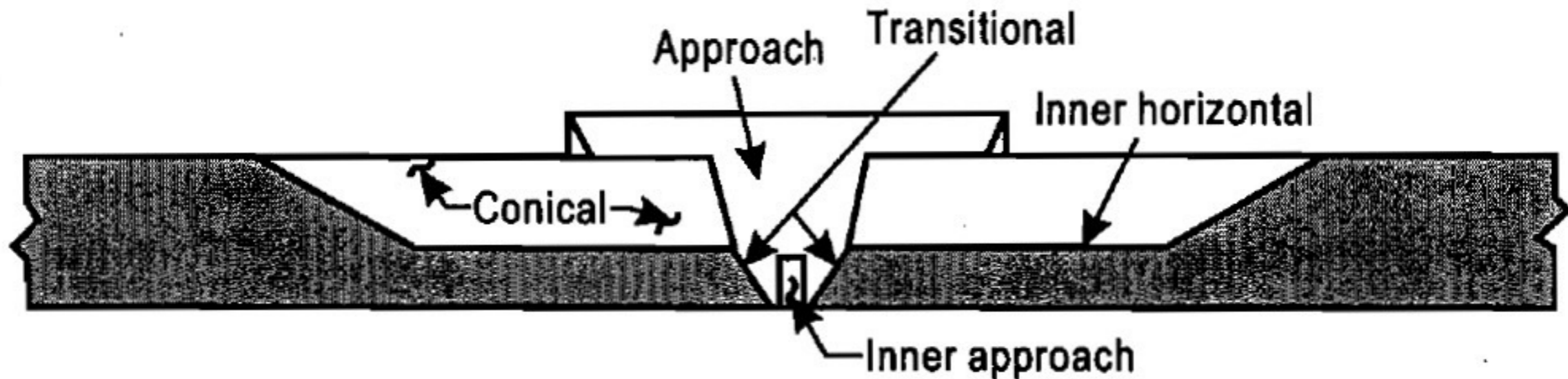

Section B-B

ICAO Aerodrome Design Manual
Volume 1: Runways



ICAO Inner Approach, Inner Transitional and Balked Landing Surfaces

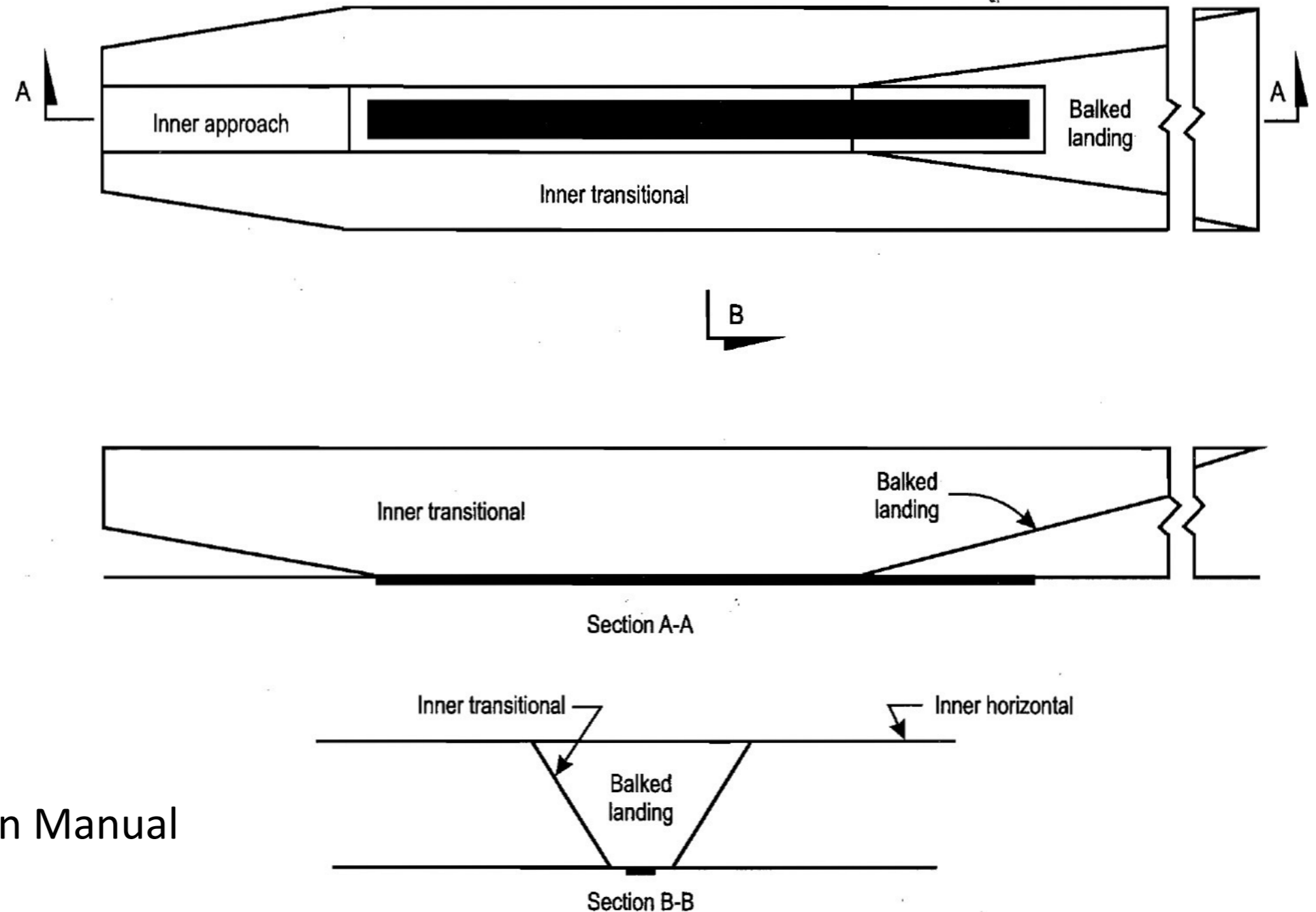

ICAO Aerodrome Design Manual
Volume 1: Runways



ICAO Dimensional Standards of Obstacle Surfaces (Approach Runways)

Surface and dimensions ^a	RUNWAY CLASSIFICATION										
	(1)	Non-instrument				Non-precision approach			Precision approach category		
		Code number				Code number			I		II or III
		2	3	4	1,2	3	4	1,2	3,4	3,4	
(2)	(3)	(4)	(5)	(6)	(7)	(8)	(9)	(10)	(11)		
CONICAL											
Slope	5%	5%	5%	5%	5%	5%	5%	5%	5%	5%	
Height	35 m	55 m	75 m	100 m	60 m	75 m	100 m	60 m	100 m	100 m	
INNER HORIZONTAL											
Height	45 m	45 m	45 m	45 m	45 m	45 m	45 m	45 m	45 m	45 m	
Radius	2 000 m	2 500 m	4 000 m	4 000 m	3 500 m	4 000 m	4 000 m	3 500 m	4 000 m	4 000 m	
INNER APPROACH											
Width	—	—	—	—	—	—	—	90 m	120 m ^e	120 m ^e	
Distance from threshold	—	—	—	—	—	—	—	60 m	60 m	60 m	
Length	—	—	—	—	—	—	—	900 m	900 m	900 m	
Slope	—	—	—	—	—	—	—	2.5%	2%	2%	

ICAO Aerodrome Design Manual
Volume 1: Runways



ICAO Dimensional Standards of Obstacle Surfaces (Approach Runways)

Surface and dimensions ^a (1)	RUNWAY CLASSIFICATION									
	Non-instrument				Non-precision approach			Precision approach category		
	Code number				Code number			I	II or III	
	1	2	3	4	1,2	3	4	Code number	Code number	Code number
(1)	(2)	(3)	(4)	(5)	(6)	(7)	(8)	1,2	3,4	3,4
(9)	(10)	(11)								
APPROACH										
Length of inner edge	60 m	80 m	150 m	150 m	150 m	300 m	300 m	150 m	300 m	300 m
Distance from threshold	30 m	60 m	60 m	60 m	60 m	60 m	60 m	60 m	60 m	60 m
Divergence (each side)	10%	10%	10%	10%	15%	15%	15%	15%	15%	15%
First section										
Length	1 600 m	2 500 m	3 000 m	3 000 m	2 500 m	3 000 m	3 000 m	3 000 m	3 000 m	3 000 m
Slope	5%	4%	3.33%	2.5%	3.33%	2%	2%	2.5%	2%	2%
Second section										
Length	—	—	—	—	—	3 600 m ^b	3 600 m ^b	12 000 m	3 600 m ^b	3 600 m ^b
Slope	—	—	—	—	—	2.5%	2.5%	3%	2.5%	2.5%
Horizontal section										
Length	—	—	—	—	—	8 400 m ^b	8 400 m ^b	—	8 400 m ^b	8 400 m ^b
Total length	—	—	—	—	—	15 000 m	15 000 m	15 000 m	15 000 m	15 000 m

ICAO Aerodrome Design Manual Volume 1: Runways

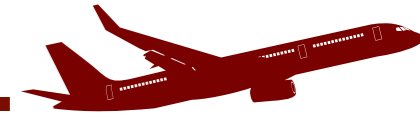

ICAO Dimensional Standards of Obstacle Surfaces (Approach Runways)

Surface and dimensions ^a	RUNWAY CLASSIFICATION									
	1	Non-instrument			Non-precision approach			Precision approach category		
		Code number	Code number	Code number	Code number	Code number	Code number	Code number	Code number	Code number
(1)	(2)	(3)	(4)	(5)	(6)	(7)	(8)	(9)	(10)	(11)
TRANSITIONAL										
Slope	20%	20%	14.3%	14.3%	20%	14.3%	14.3%	14.3%	14.3%	14.3%
INNER TRANSITIONAL										
Slope	—	—	—	—	—	—	—	40%	33.3%	33.3%
BALKED LANDING SURFACE										
Length of inner edge	—	—	—	—	—	—	—	90 m	120 m ^e	120 m ^e
Distance from threshold	—	—	—	—	—	—	—	^c	1 800 m ^d	1 800 m ^d
Divergence (each side)	—	—	—	—	—	—	—	10%	10%	10%
Slope	—	—	—	—	—	—	—	4%	3.33%	3.33%

- a. All dimensions are measured horizontally unless specified otherwise.
- b. Variable length (see 4.2.9 or 4.2.17).
- c. Distance to the end of strip.
- d. Or end of runway whichever is less.
- e. Where the code letter is F (Column (3) of Table 1-1), the width is increased to 155 m.

ICAO Aerodrome Design Manual Volume 1: Runways



ICAO Dimensional Standards of Obstacle Surfaces (Takeoff Runways)

RUNWAYS MEANT FOR TAKE-OFF

Surface and dimensions ^a	Code number		
	1	2	3 or 4
(1)	(2)	(3)	(4)
TAKE-OFF CLIMB			
Length of inner edge	60 m	80 m	180 m
Distance from runway end ^b	30 m	60 m	60 m
Divergence (each side)	10%	10%	12.5%
Final width	380 m	580 m	1 200 m 1 800 m ^c
Length	1 600 m	2 500 m	15 000 m
Slope	5%	4%	2% ^d

- a. All dimensions are measured horizontally unless specified otherwise.
- b. The take-off climb surface starts at the end of the clearway if the clearway length exceeds the specified distance.
- c. 1 800 m when the intended track includes changes of heading greater than 15° for operations conducted in IMC, VMC by night.
- d. See 4.2.24 and 4.2.26.

ICAO Aerodrome Design Manual Volume 1: Runways



Practical Application of ICAO Obstacle Limiting Surfaces

Shanghai (SHA) Airport
North End

Displaced
threshold to
meet approach
or departure
surfaces





Study of Airports in the United States Eastern Region



Studied 2,223 airports in the Eastern United States

- Studied 2,223 airports in the US.
- Analyzed controlling object for each runway end
- Studied many other characteristics of each runway including their Wide Area Augmentation System qualification surfaces



Case Study Region

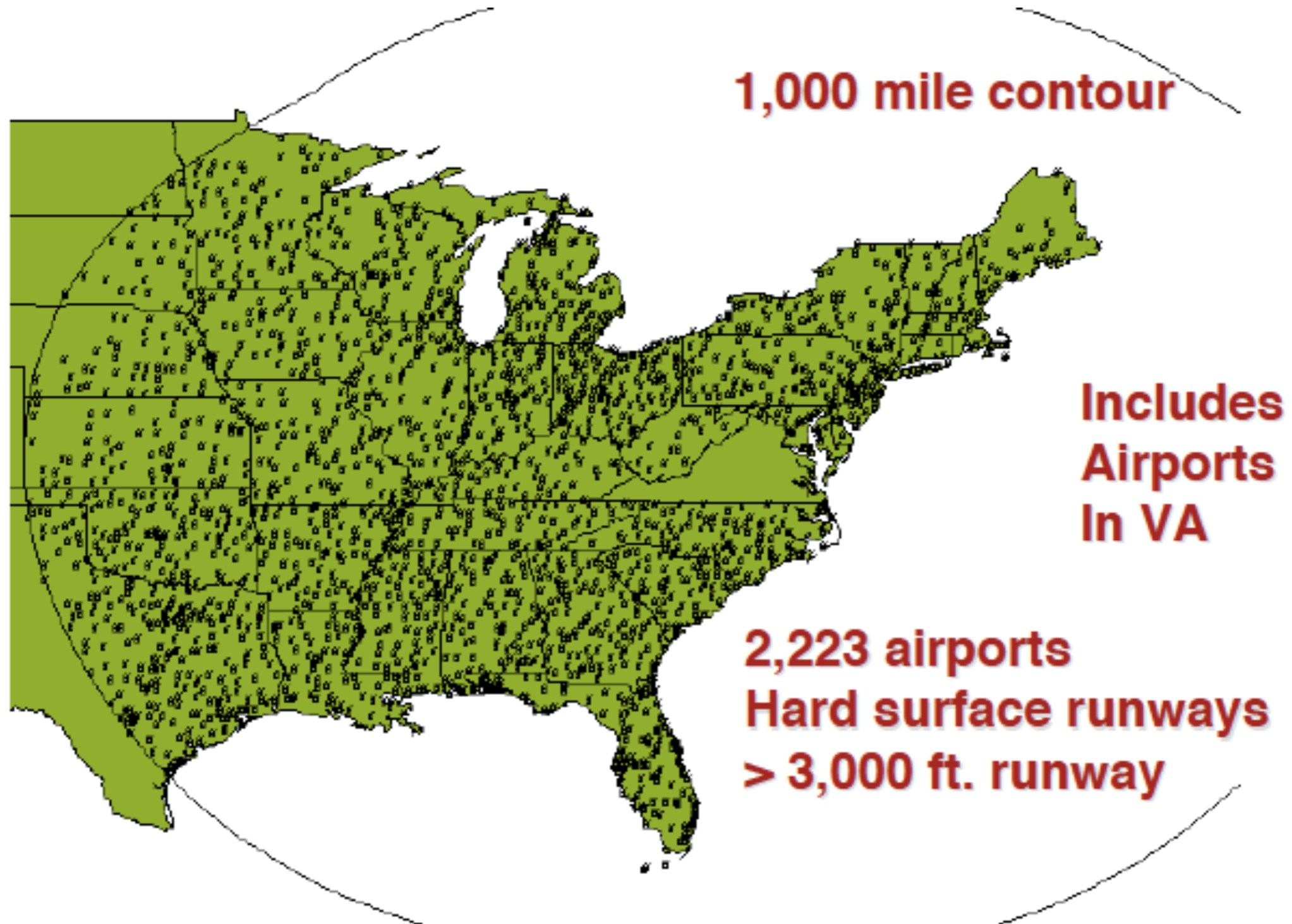



State of Runway Lengths

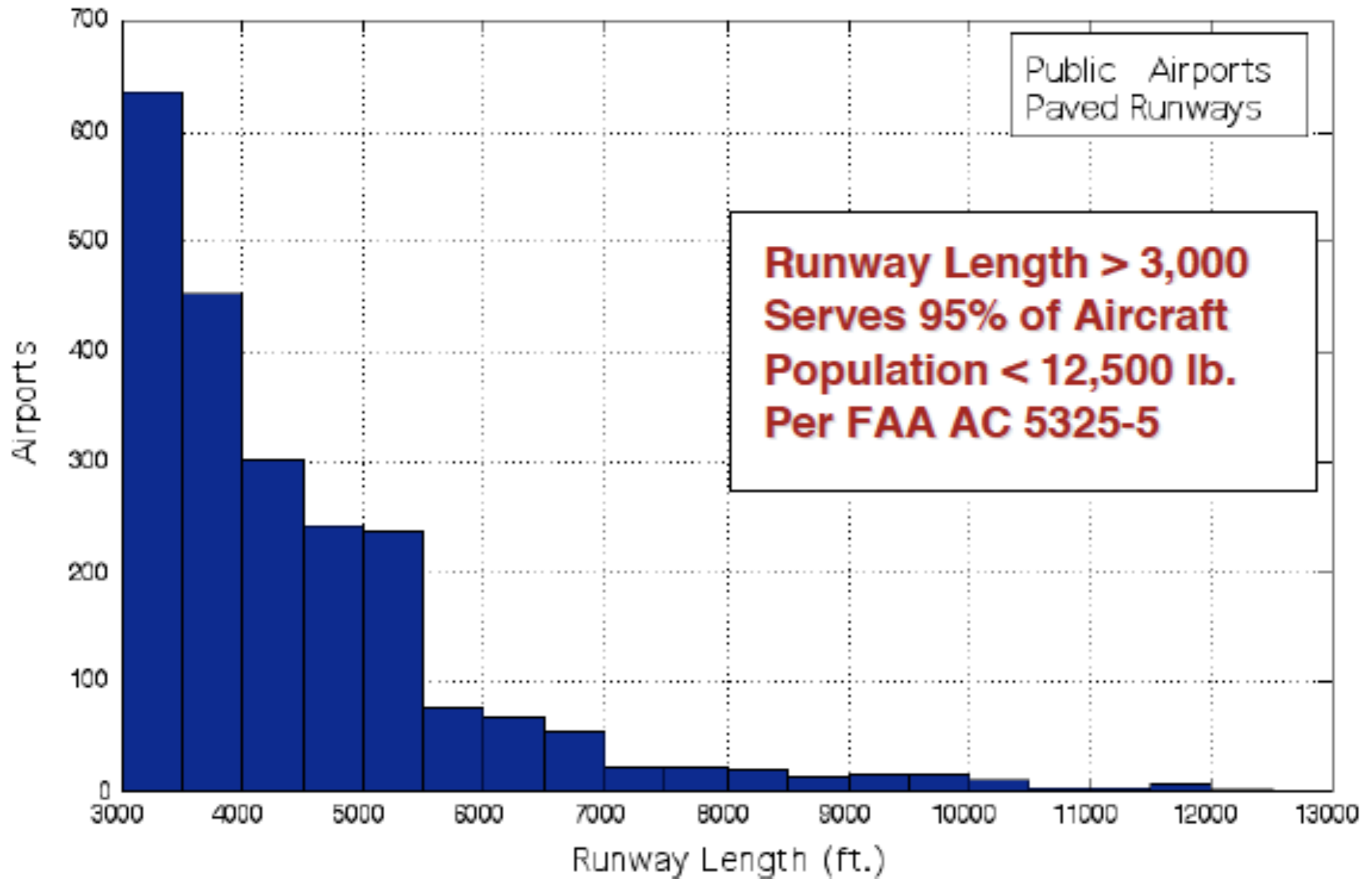



Runway Operations

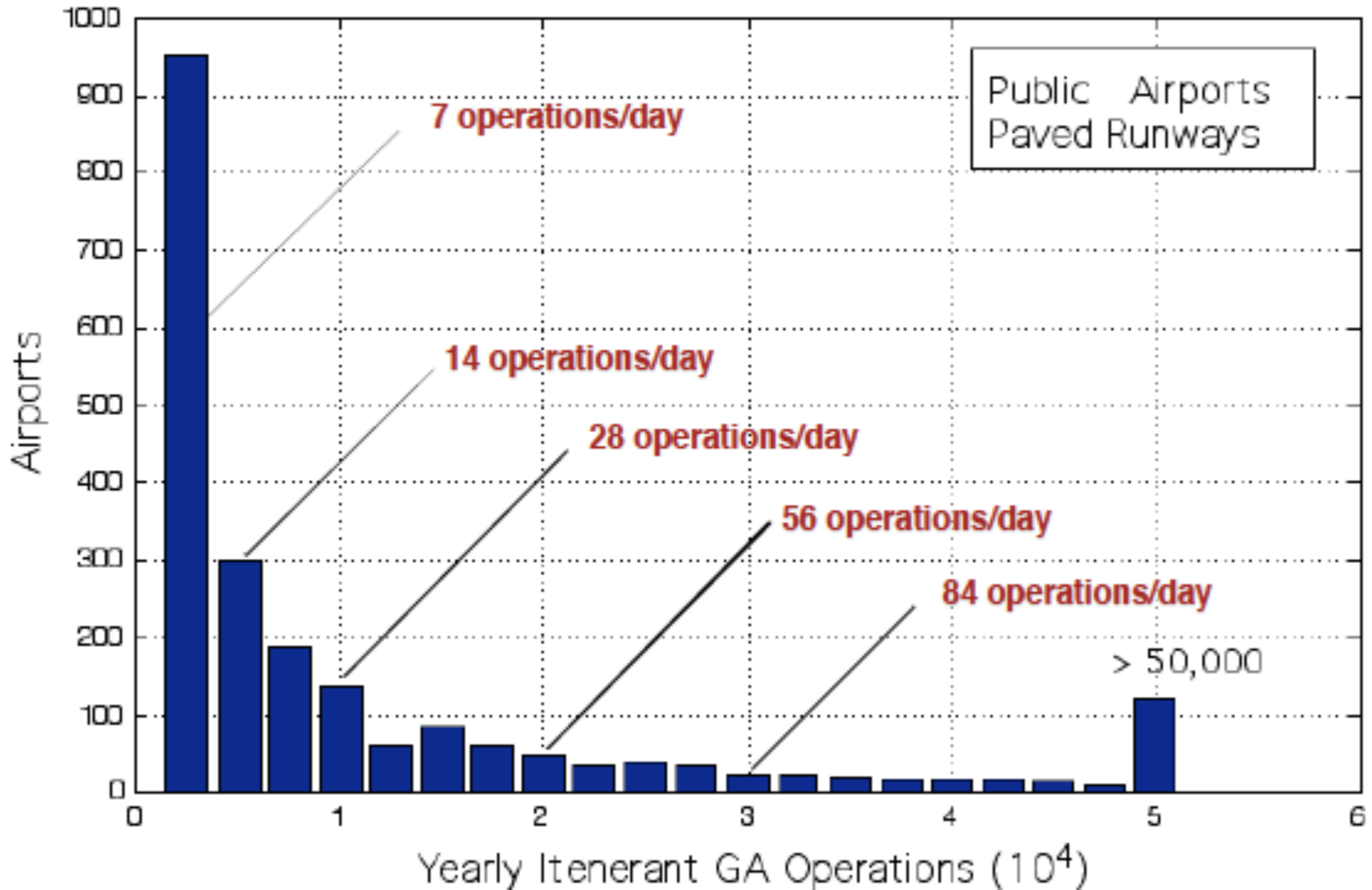



State of Runway Approach Lights

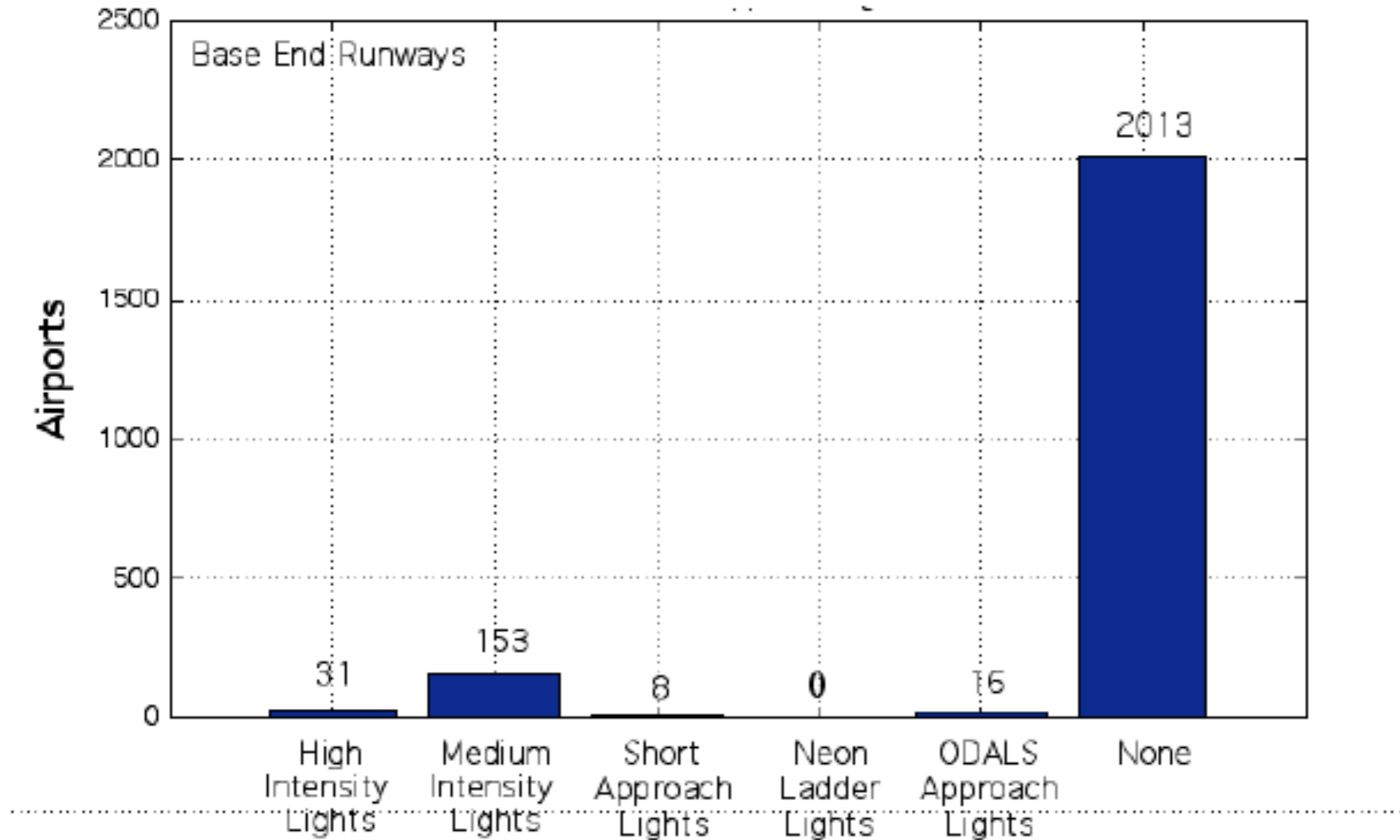



Type of Approaches Available

Data on GPS approaches is being collected

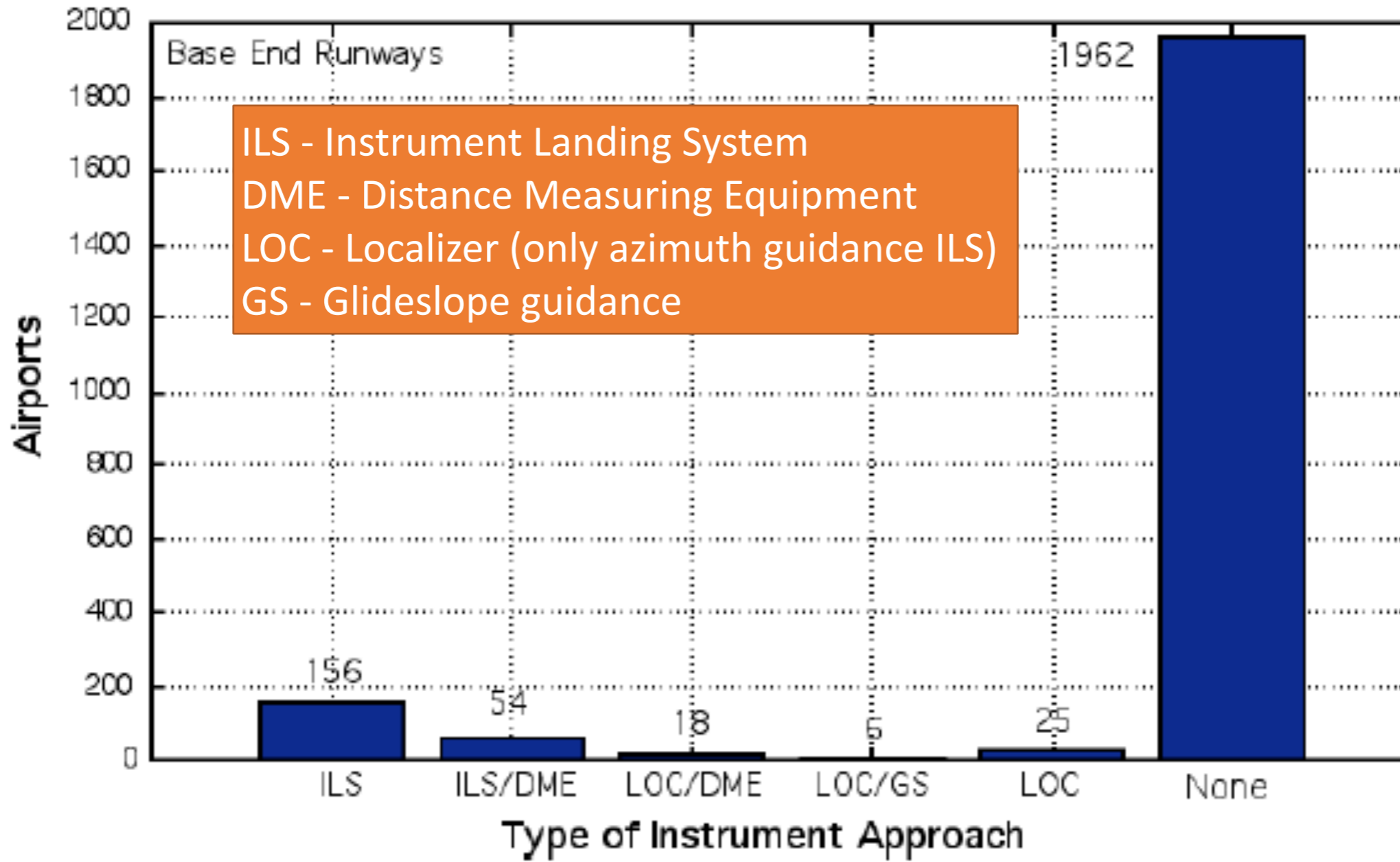



FAR Part 77 Design Criteria

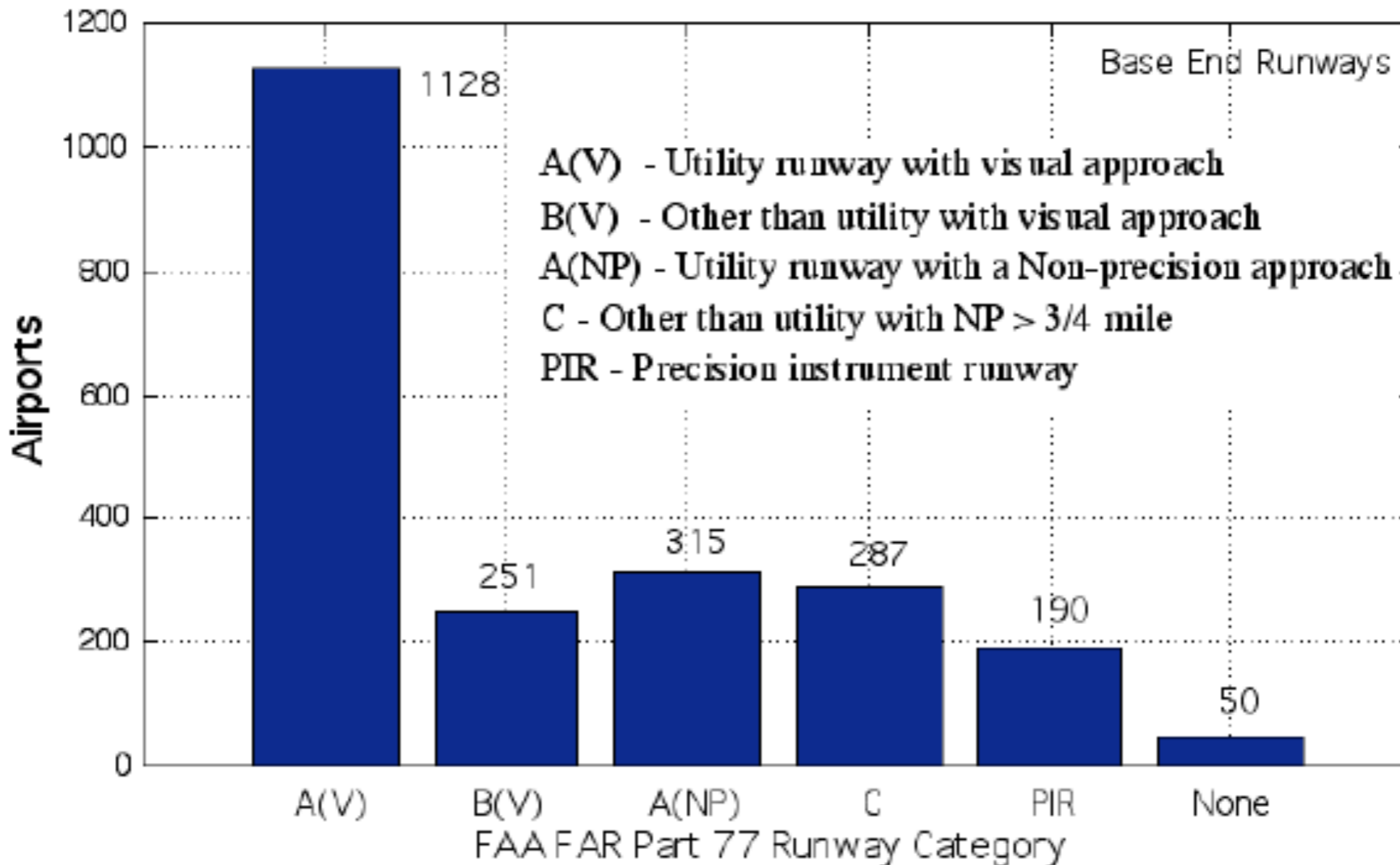



Remarks

- About 9% of the runways surveyed (at 2,221 airports) has an approach lighting system today
- Today, 11% of the runways have some type of instrument approach (not all precision approaches though)
- The percent of Precision Instrument Runways (PIR) - about 8.5% of all runways surveyed - the number is consistent with the 9% of runways having approach lighting systems (9%)



Slope of Controlling Objects (Part 77)

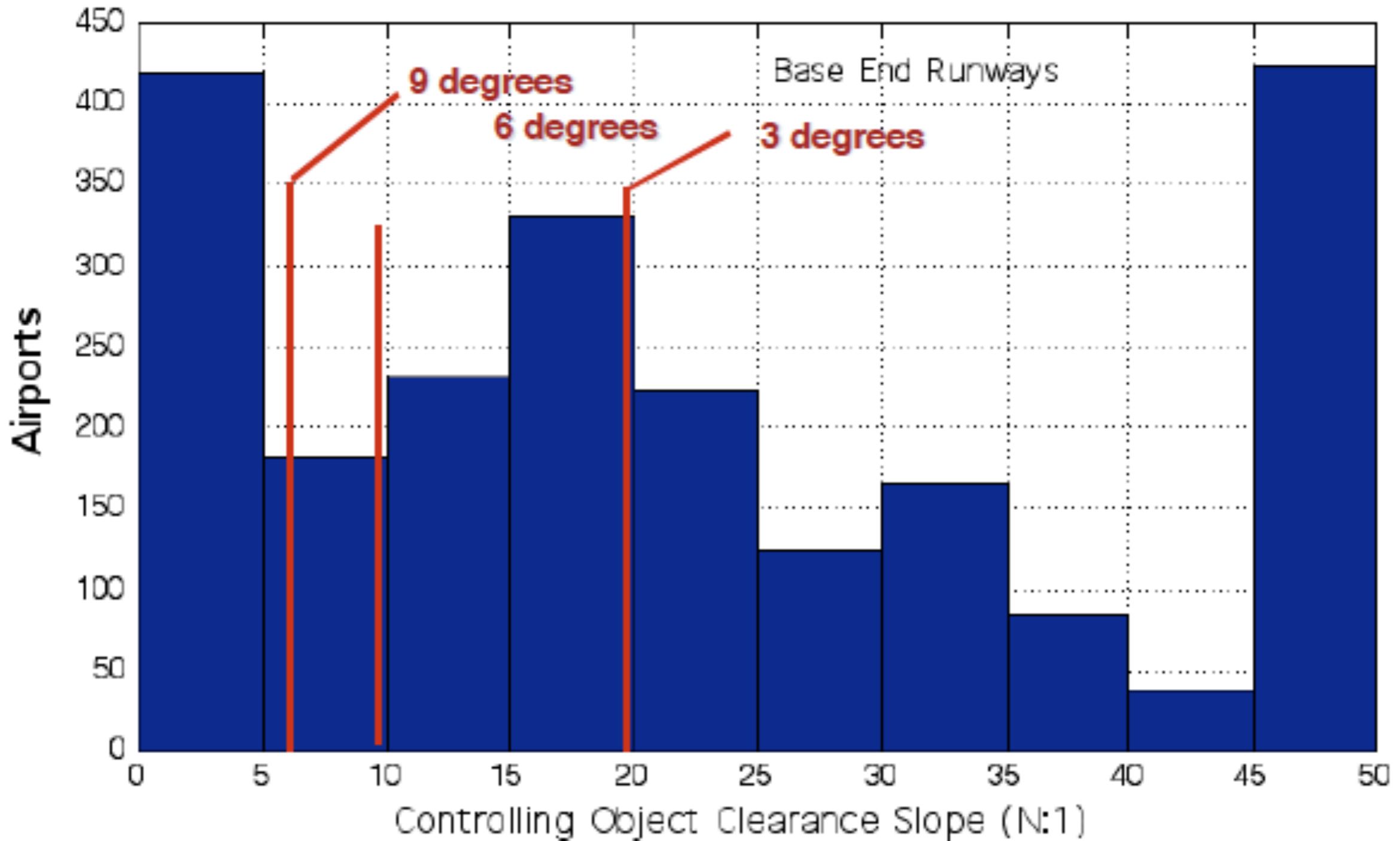



Location of Controlling Objects

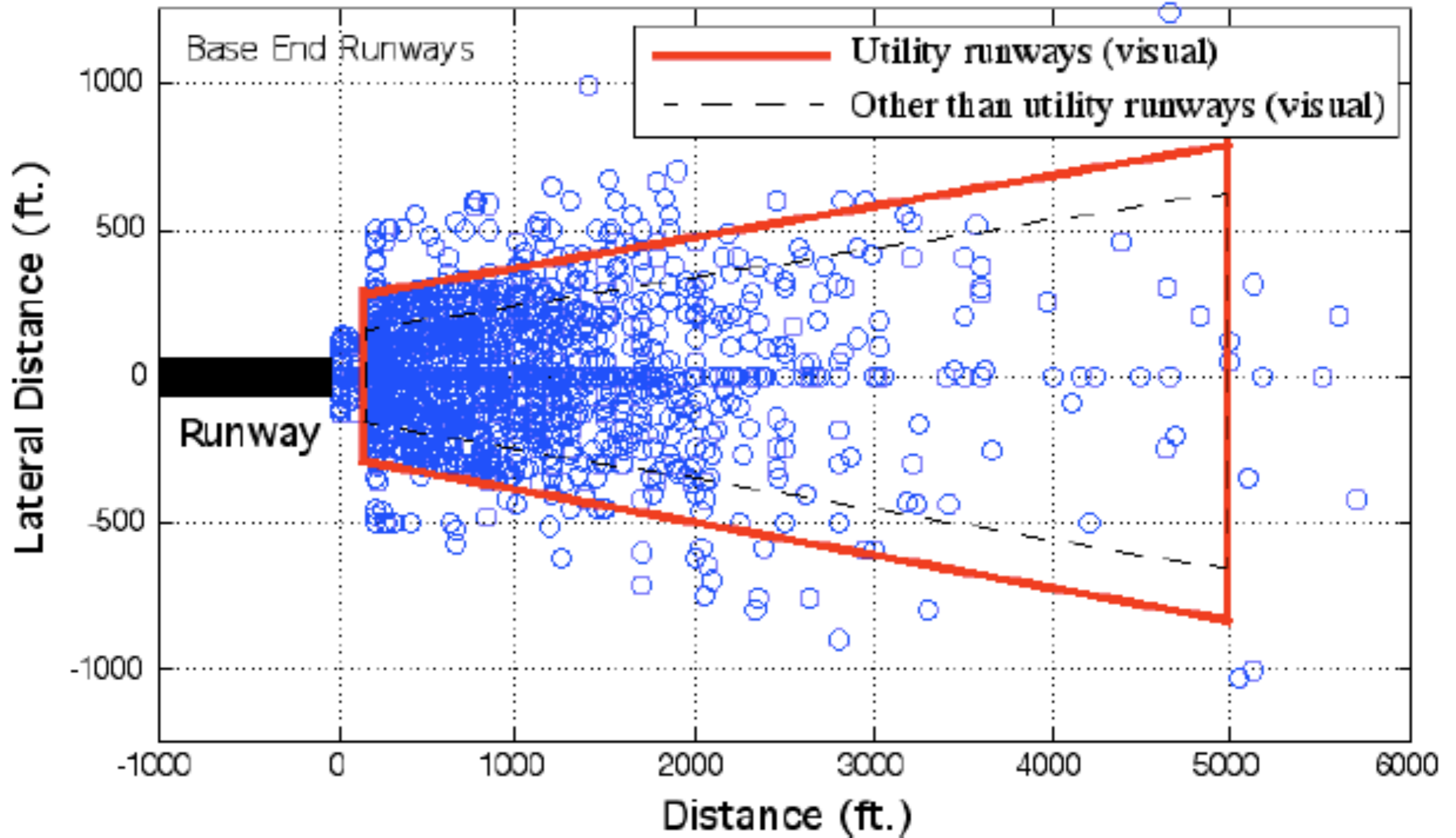



Remarks About Controlling Objects

- More than 62% of the base runway configurations examined (2,221 base runways) have controlling object clearance slopes below 20:1 (quite bad even if off-set or curved approaches are used)
- Under current FAA rules only 19% of the airports surveyed in the FAA database could be candidates for upgrade to Precision Instrument Runway (PIR) criteria given the state of controlling object locations
- Other precision instrument equipment site location considerations would probably reduce this number further